

RC series grain color sorter

Content

1. Optical Sorter Machine Structure.....	3
2. Opening Procedure.....	4
3. Vibratory feeder cleaning and maintenance	4
4. Chutes cleaning and maintenance.....	10
5. Filter cleaning and maintenance.....	13
6. Relief valve cleaning and maintenance.....	14
7. Optical sorter fuse identification and Replacement.....	15
8. optical sorter dust cylinder cleaning and maintenance.....	17
9. Discharge hopper cleaning	20
10. Air extraction hopper cleaning and maintenance.....	22
11. Air compressor/dryer cleaning and maintenance.....	23

1, Machine Structure

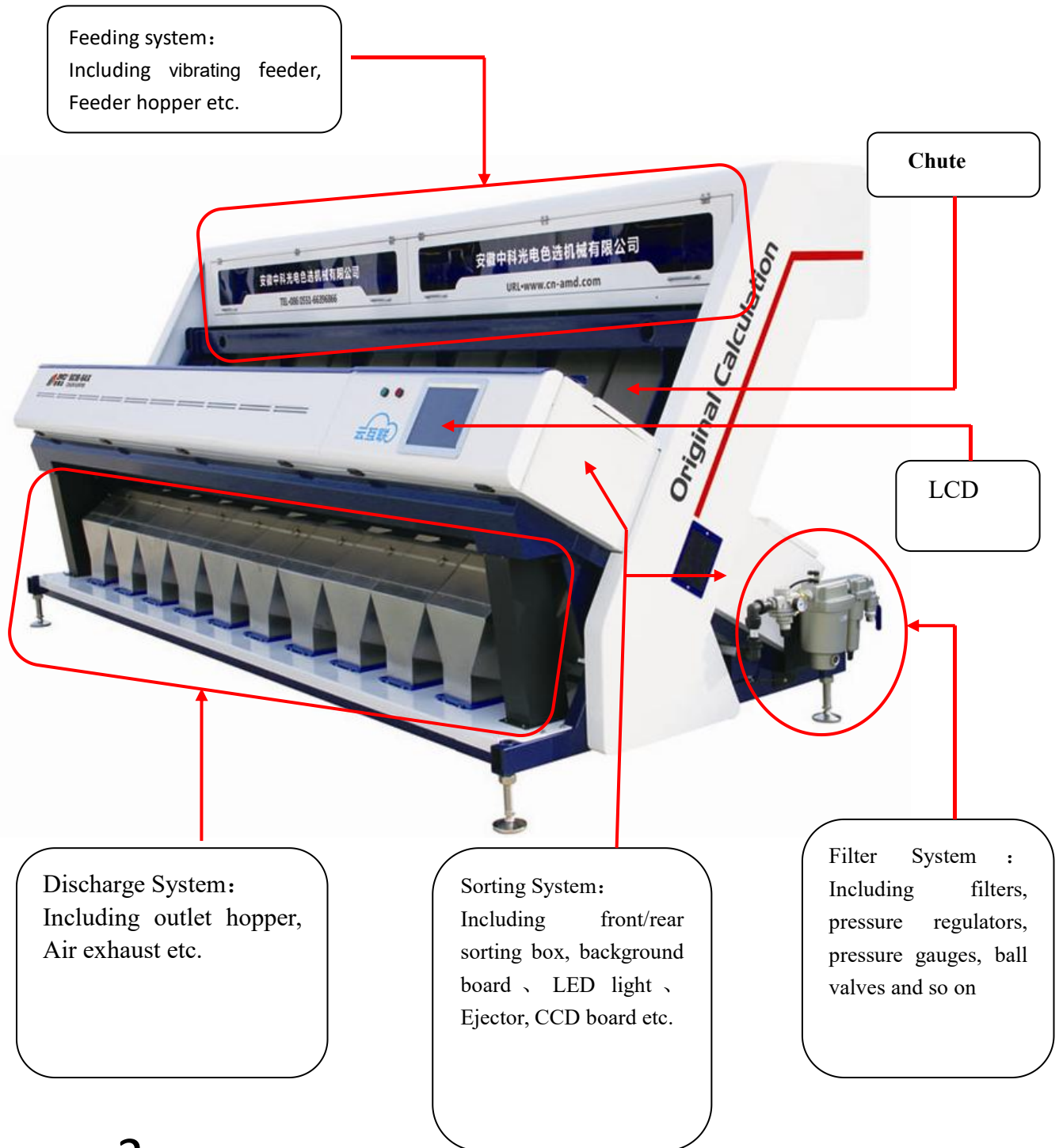

2, Machine Opening Procedure:

Step 1: Open the Air dryer (optional), air compressor, so that the Air tank has enough work pressure;

Attention : Before turn on machine, please check whether the valves in the air supply system are in the normal status.

Step 2: Connect the color sorter machine with the main power supply;



Open the air switch



Open the electricity stabilizer

Step 3: Press the door panel power button,



Turn on/off power on the door panel

3,Color sorting box glass cleaning and maintenance

Step1: Open the side of the color sorter



Step2: Observe whether the interior glass is clean, and whether the window is clean on both sides;

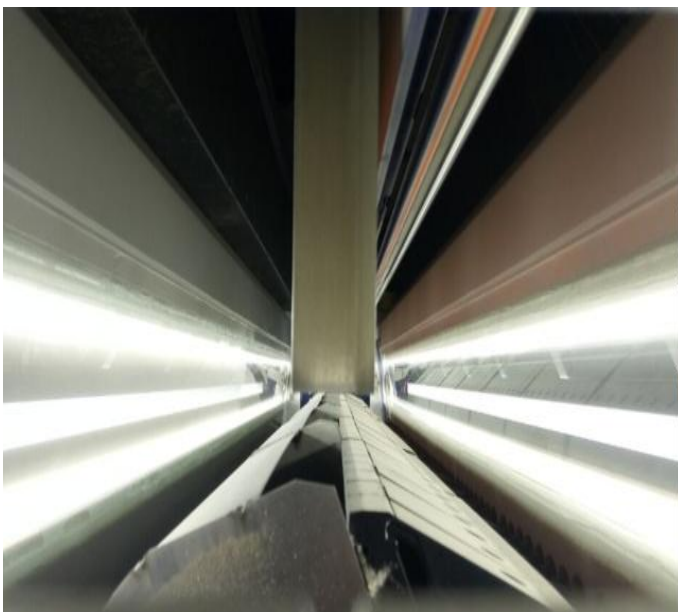

Color sorting box glass cleaning and maintenance

Step3: When you find a large number of dust on both sides of the sorting room, clean up with an air gun;

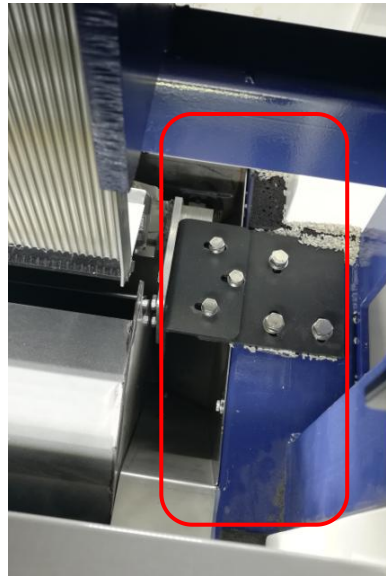

Clean the powder on both sides with an air gun

Step 4: When found dust dirt on both sides of the sorting room glass, with alcohol, gauze for processing;



There are dust on both sides of the glass

Optical sorter room glass maintenance

Step 5: Buy a amount of medical alcohol, medical gauze or masks;



Step 6: The gauze or masks are folded flat, the length is slightly longer than the glass clean brush

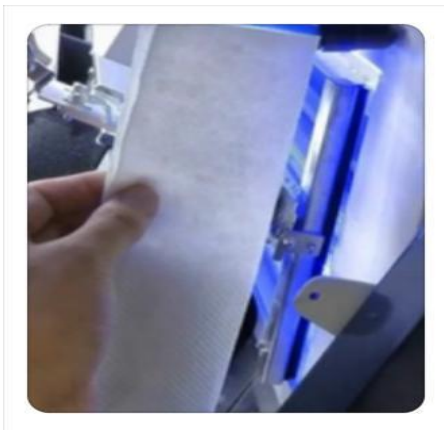

① Flatten the gauze or mantle

② the length is slightly longer than the glass clean skin

Step 7: Put the folded gauze or mask with alcohol;



Color sorting box glass cleaning and maintenance

Step 8: Loose Cleaning Brush Skin Fixing Screws, the gauze or masks flat under the rubber brush in the bottom with alcohol, Tighten the cleaning brush screw.

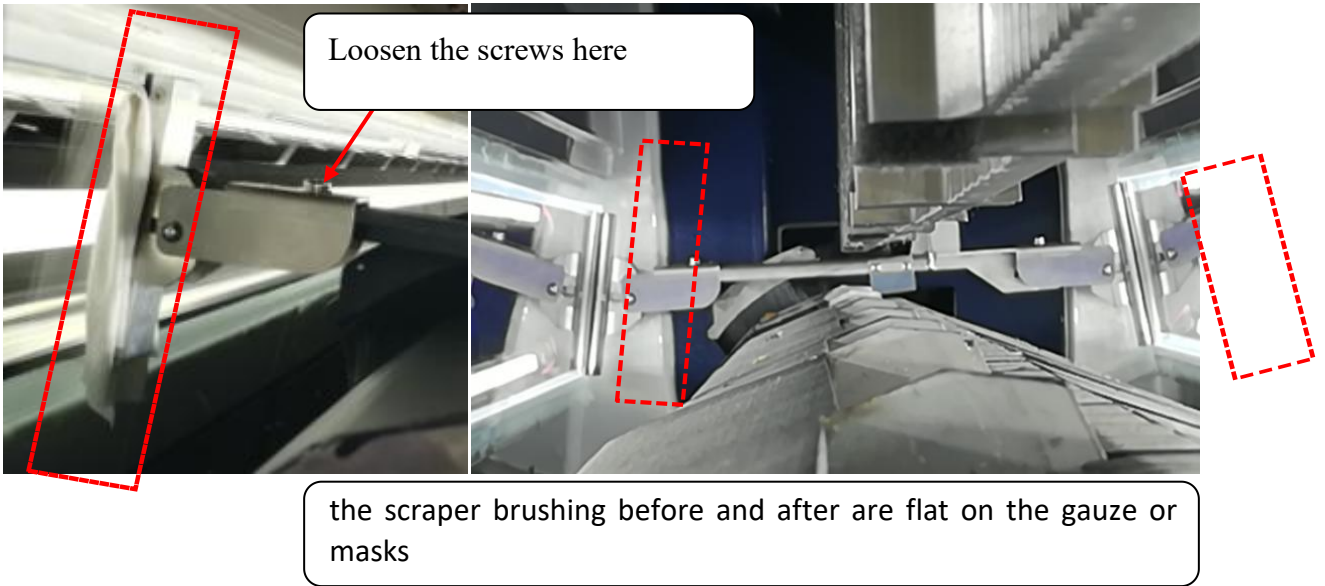

Step 9: Click on the main interface of the display "Sys para", then click Wiper Set

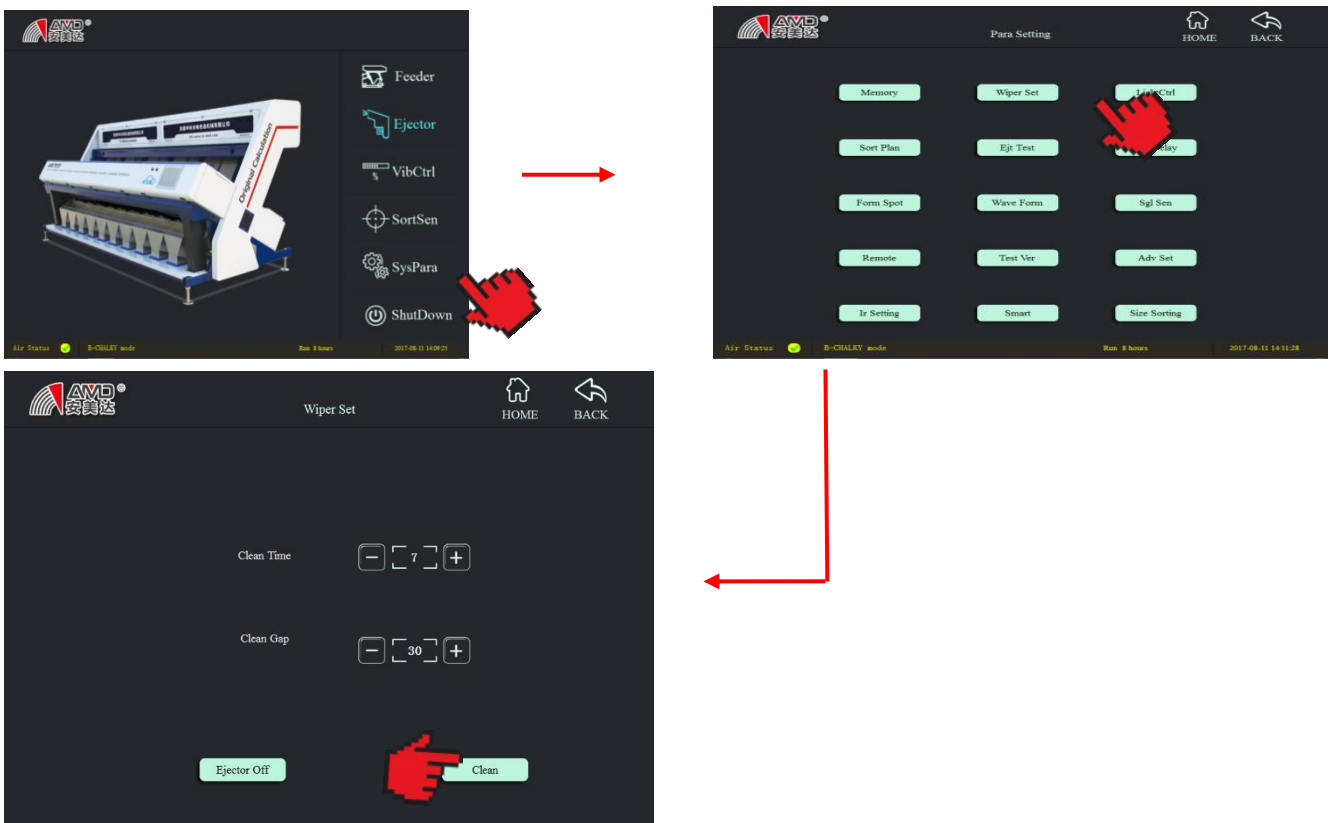

5, Vibratory feeder cleaning and maintenance

Step1: Clean the dust on the vibrator platform;



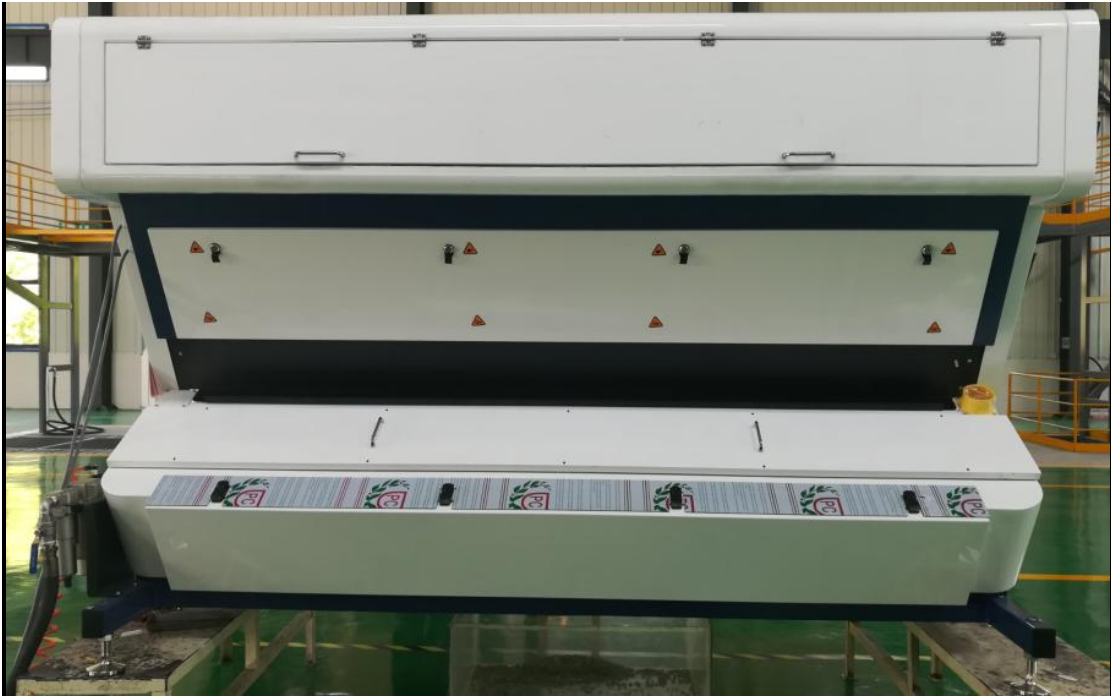

Vibrator platform

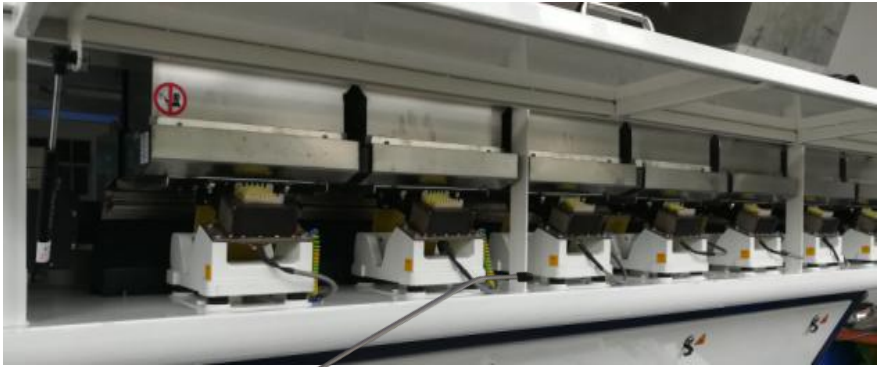

Daily get off work: Clean the dust on the platform with a air gun

Vibrator、 vibrating feeder cleaning and maintenance

Step2: Clean the vibrator feeder dust;



Daily get off work: Clean the dust on the Vibrator feeder with a gun

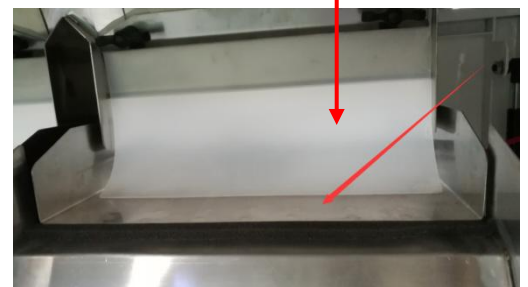

Step3: If the vibrator feeder with dirt or grain, clean it with a flat shovel;

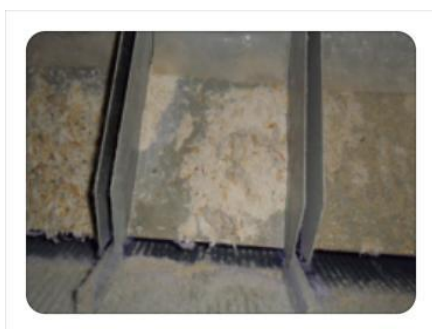

4.Chutes cleaning and maintenance

Step1: Clean the dust on the chute;



Chutes

Note: Do not use "iron and other sharp objects" to clean up Material chutes dust, foreign matter!



Accumulated work 8 hours later, with a gas gun to clean the dust on the chutes, foreign matter.

Chutes cleaning and maintenance

Step2: When the channel with chaff or fouling and other dirt, with medical alcohol, medical gauze, masks to clean up;



Step3: If the channel is damaged by hard objects, it can be polished with fine sandpaper;



With more than 600 mesh fine sandpaper grinding damaged channel



5. Optical sorting machine filter cleaning, maintenance

Step1: The Optical sorting machine is equipped with a filter for cleaning and replacement;

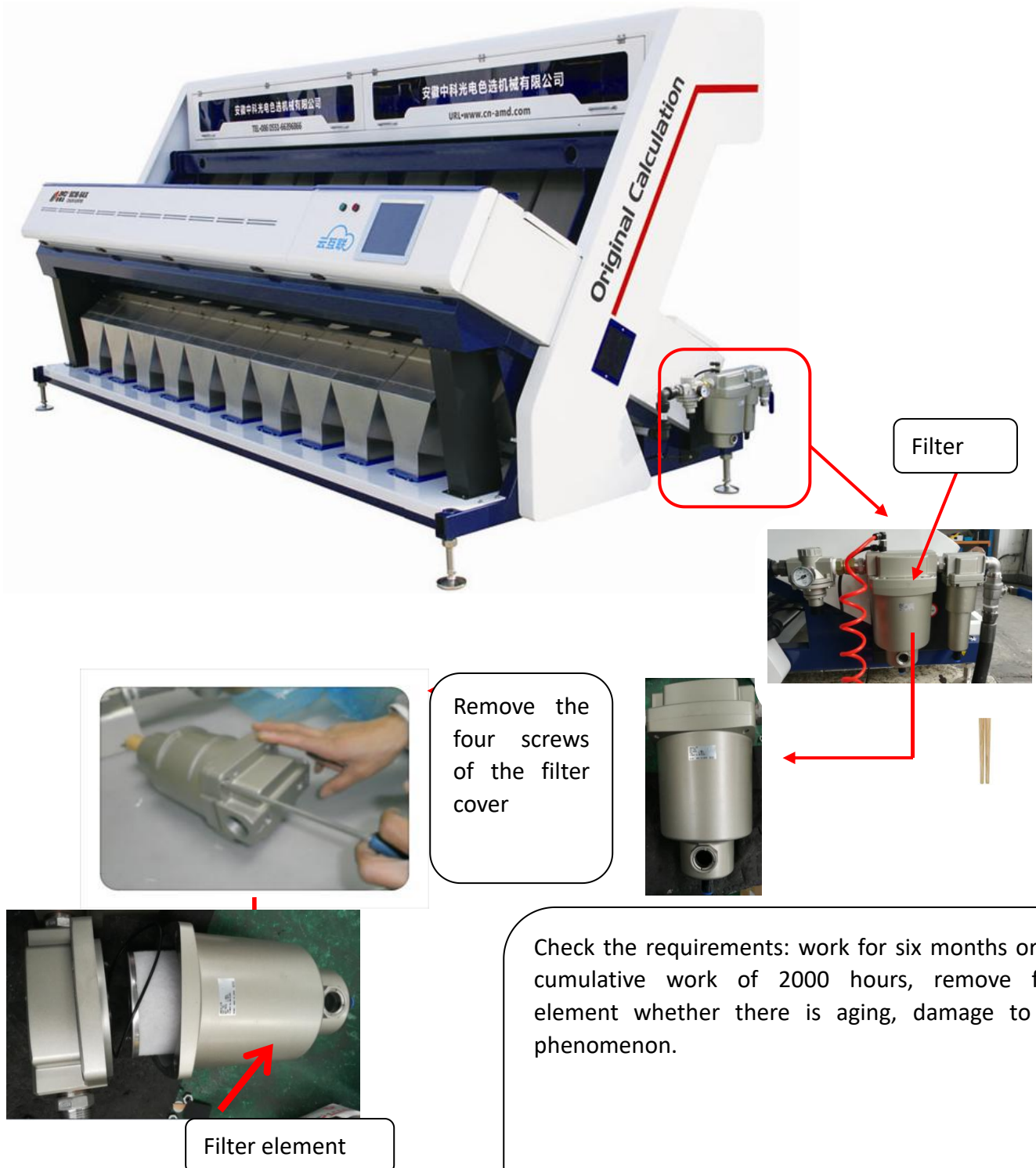

6. Optical Sorter Relieve Valve Use Method



Relieve Valve

Step one:

Pressure adjustment method: Rotate the handle under the bottom of the relief valve to adjust the pressure

Pressure value: Color Sorter standard working pressure is between 0.3Mpa and 0.4Mpa



Pressure adjustment method:

1. Rotate clockwise to increase the pressure
2. Rotate counterclockwise to decrease the pressure

Black adjustment handle

7. Optical Sorter Fuse Identification and Replacement

Step one: Identify and disassemble the fuse on the optical sorter terminal



Unlock the door

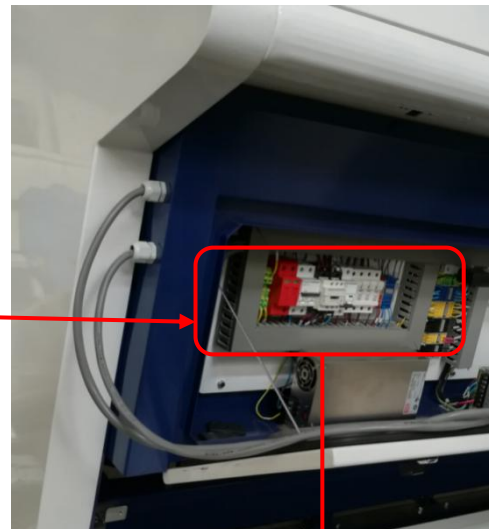

Fuse on the terminal

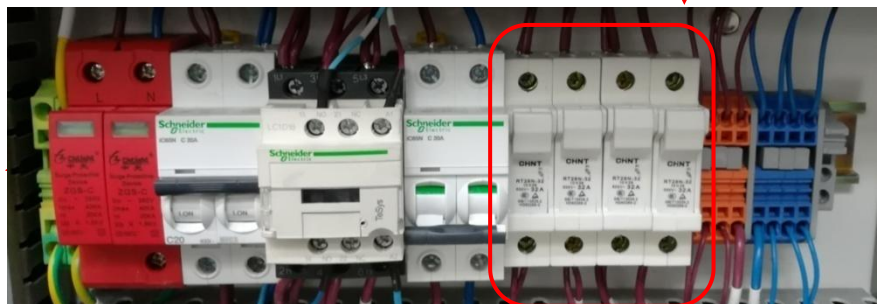

 Warning: Disconnect the color sorter main power supply before replacing the fuse to prevent electric shock

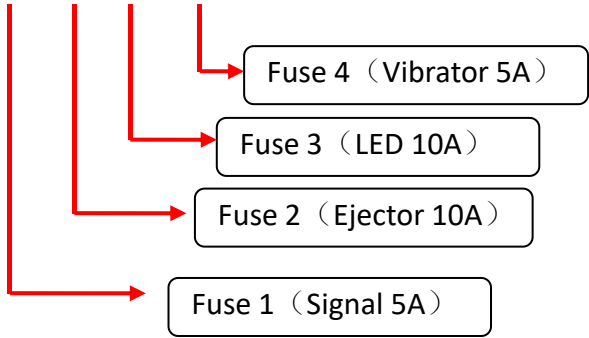

Optical sorter Fuse Identification and Replacement

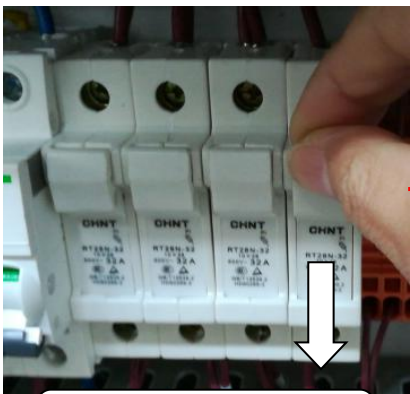

Pull down fuse box



Get the fuse out of the box



Step two: Identify the ampere of the optical color sorter machine fuse



Check the Ampere specifications on this label



Warning: The new fuse must have the same specifications with the old replaced fuse

8. Optical Sorter Dust-cleaning cylinder cleanliness and maintenance

Step one: Cut off the air supply, open the protect cover at the rear of the dust-cleaning cylinder

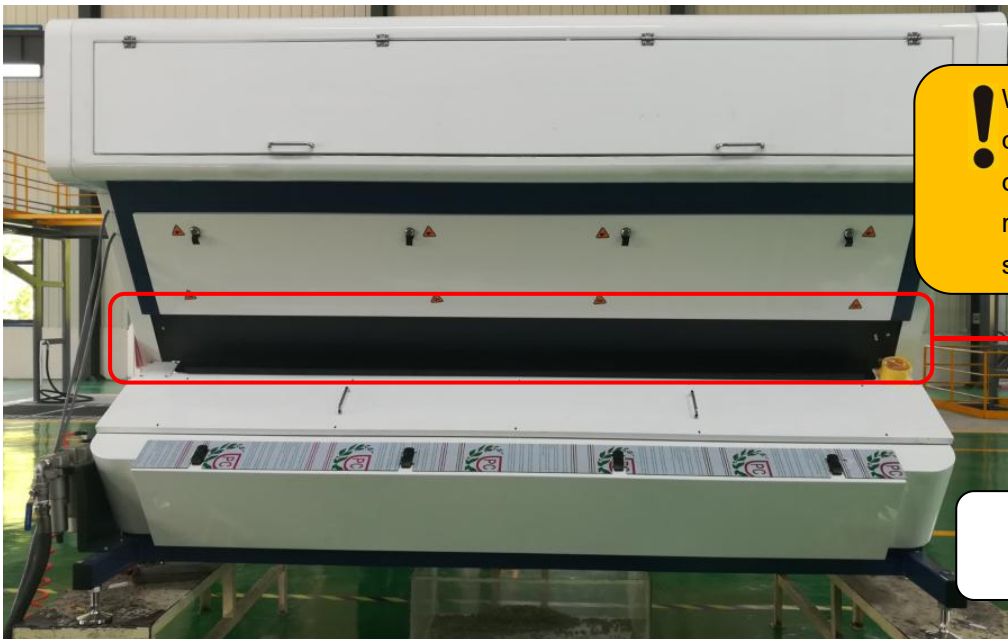

Warning: Before this operation, color sorter air supply must be cut off, must use the air gun to release all the left air in the color sorter

Cylinder protect cover



Disassemble the screws at the two sides of protect cover and get the cover off

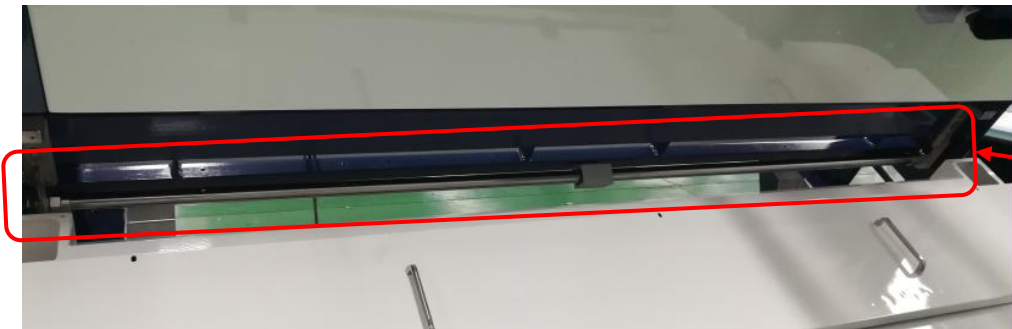

Cylinder

Optical Sorter Dust-cleaning cylinder cleanness and maintenance

Step two: Use the air gun to clean inside dust and foreign matters

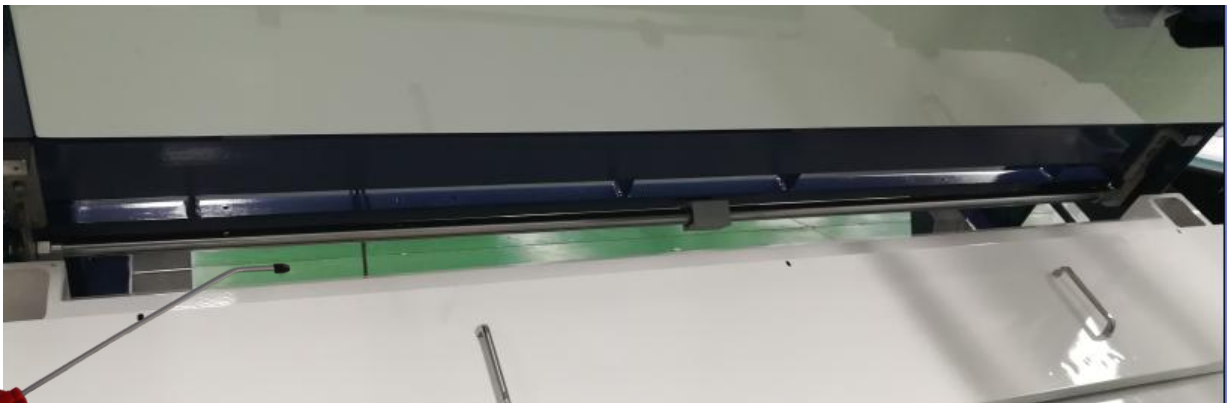

! Cleaning requirement: At least one time per week

Step Three: Prepare some alcohol, gauze, masks and clean it



Optical Sorter Dust-cleaning cylinder cleanness and maintenance

Step four: Wet the gauze and the mask with alcohol and then wipe the cleaning cylinder

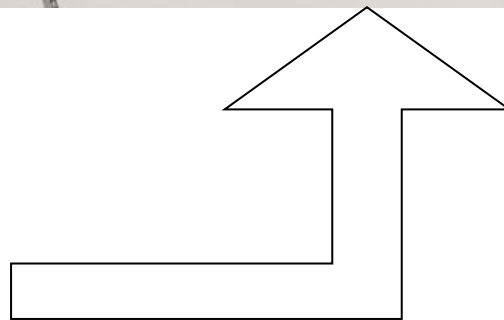
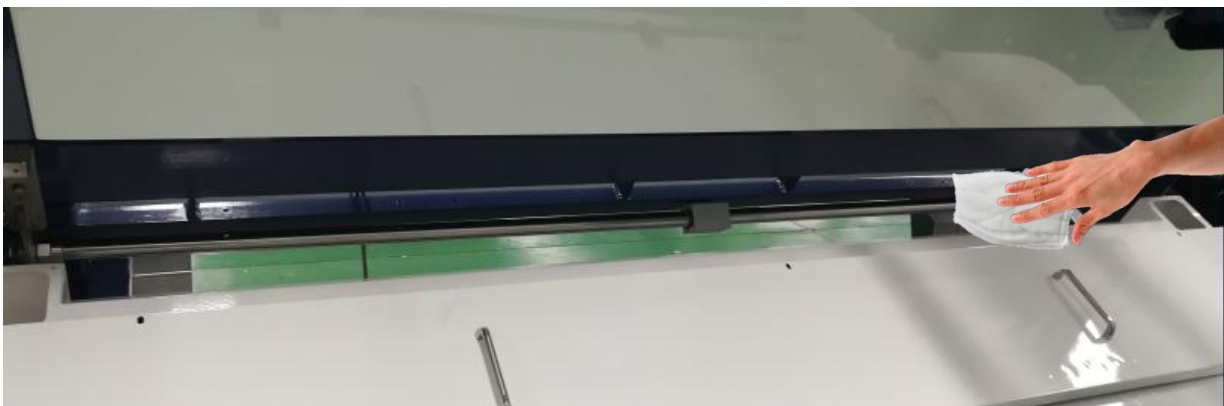

! Cleaning requirement: Use the wet gauze with alcohol to clean the dust and dirt on the surface of cylinder

Step five: Assemble the protect cover after cleaning the cylinder



Assemble the screws on the two sides of the cylinder

9. Optical Sorter Discharging Hopper Cleaning

Step one: Clean up the dust in the hopper, open the viewing window and clean the dust and dirt with air gun.



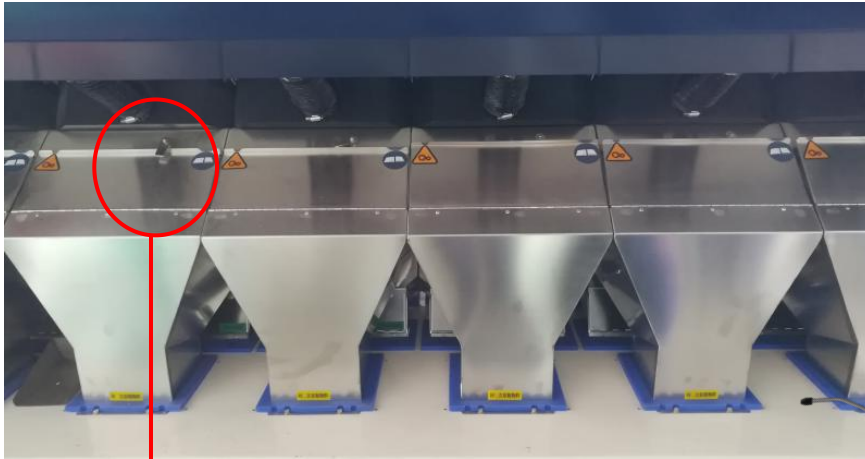

Unlock the window



Use the air gun to clean the dust and dirt inside and outside of the discharging hoppers after every shift work

10. Optical Sorter Down Air Extrction Cleaning

Air extraction tube



Step one: Unscrew the screws of the air extraction tube, loosen the clamp screws and get the tube off.

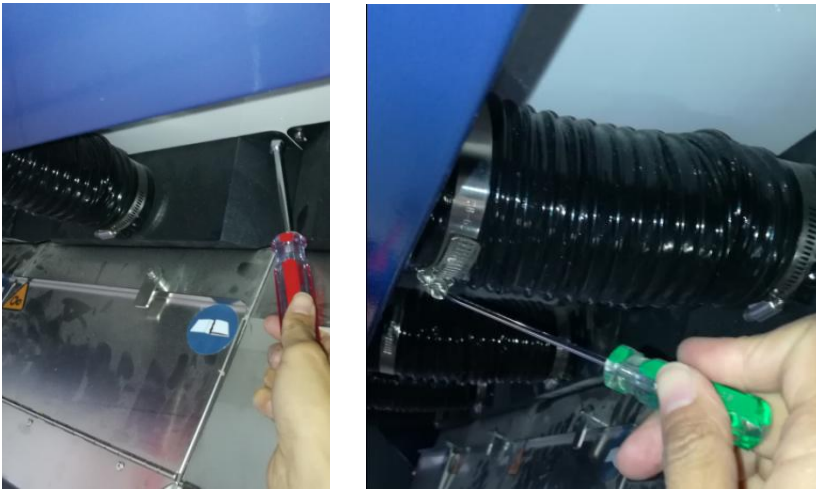

Step two: Use the air gun to clean up the dust and foreign matters inside and outside of the tube

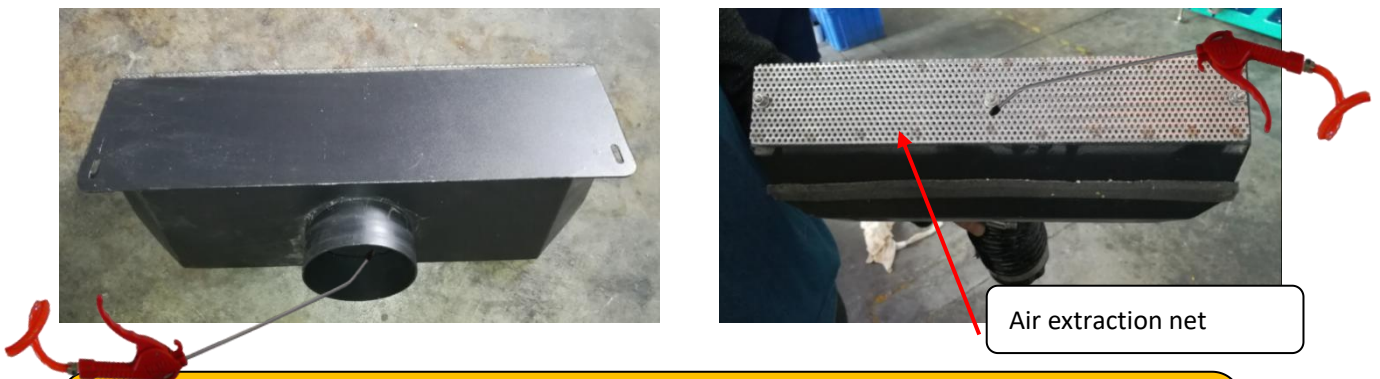

! Cleaning requirement: At least one time per week to ensure the sorting performance

11. Air compressor and dryer cleaning and maintainance

Step one: Maintain and replace the air compressor filters as manufacturer requirement



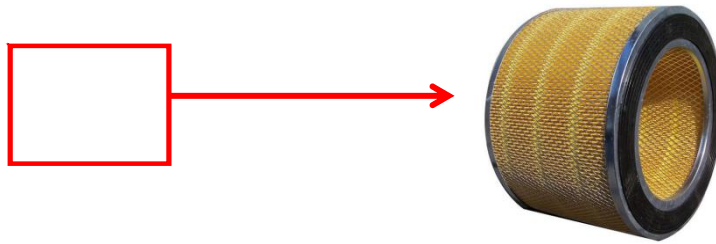

Step two: Drain off all the water in the air compressor, air dryer and air tank every day



After every shift work, open the valves under the air compressor and air tank to drain off the air and water, then close the valve

Air compressor and dryer cleaning and maintainance

Step Three: Air compressor daily cleaning and maintaining





1. After every shift work, open the side door of the air compressor, use the gun to clean the filter mesh form inside to outside
2. Every day open the filter water draining switch to drain off the water and check if any oil exists in the water, if it has oil inside, please replace the filter
3. Replace the air filters as per manufacturer requirements

Step 4: Air compressor daily Cleaning and maintaining



After every shift work, open the side door of the dryer, use the air gun to clean the cooling net. If the air inlet is hot and air outlet is cool, the air dryer performance is good. Drain off the water regularly